

## **SURAT KETERANGAN**

Nomor: 1650/UNUSA-LPPM/Adm.I/VIII/2022

Lembaga Penelitian dan Pengabdian Kepada Masyarakat (LPPM) Universitas Nahdlatul Ulama Surabaya menerangkan telah selesai melakukan pemeriksaan duplikasi dengan membandingkan artikel-artikel lain menggunakan perangkat lunak **Turnitin** pada tanggal 22 Agustus 2022.

Judul : Estimation of closed hotels and restaurants in Jakarta as impact of corona virus disease spread using adaptive neuro fuzzy inference system

Penulis : Mohamad Yusak Anshori, Teay Shawyun, Dennis V Madrigal, Dinita Rahmalia, Fajar Annas Susanto, Teguh Herlambang, Dieky Adzkiya

No. Pemeriksaan : 2022.08.29.608

Dengan Hasil sebagai Berikut:

**Tingkat Kesamaan diseluruh artikel (*Similarity Index*) yaitu 9%**

Demikian surat keterangan ini dibuat untuk digunakan sebagaimana mestinya.

Surabaya, 29 Agustus 2022

Ketua LPPM



UNUSA  
LPPM

Achmad Syafiuddin, Ph.D

NPP: 20071300

# Estimation of closed hotels and restaurants in Jakarta as impact of corona virus disease spread using adaptive neuro fuzzy inference system

*by Fajar Annas Susanto 9*

---

**Submission date:** 22-Aug-2022 02:39PM (UTC+0700)

**Submission ID:** 1885385686

**File name:** e\_estimation.pdf (673.37K)

**Word count:** 5377

**Character count:** 28192

## Estimation of closed hotels and restaurants in Jakarta as impact of corona virus disease spread using adaptive neuro fuzzy inference system

Mohamad Yusak Anshori<sup>1</sup>, Teay Shawyun<sup>2</sup>, Dennis V. Madrigal<sup>3</sup>, Dinita Rahmalia<sup>4</sup>,  
Fajar Annas Susanto<sup>5</sup>, Teguh Herlambang<sup>5</sup>, Dieky Adzkiya<sup>6</sup>

<sup>1</sup>Department of Management, University of Nahdlatul Ulama Surabaya, Surabaya, Indonesia

<sup>2</sup>Suwarnabhumi Vocational Institute of Technology, Phra Nakhon Si Ayutthaya, Thailand

<sup>3</sup>University of Negros Occidental-Recoletos, Bacolod, Philippines

<sup>4</sup>Department of Mathematics, University of Islam Darul Ulum, Lamongan, Indonesia

<sup>5</sup>Department of Information Systems, University of Nahdlatul Ulama Surabaya, Surabaya, Indonesia

<sup>6</sup>Department of Mathematics, Institut Teknologi Sepuluh Nopember, Surabaya, Indonesia

### Article Info

#### Article history:

Received Dec 22, 2021

Revised Feb 15, 2022

Accepted Mar 1, 2022

#### Keywords:

Adaptive neuro fuzzy inference system

Closed hotels

Corona virus disease

Estimation

Restaurants

### ABSTRACT

Corona virus disease (COVID-19) have become a world health problem because they have attacked many people worldwide. Because this virus has spread massively in almost all countries, including Indonesia, the Indonesian government made some policies and rules to close down the hotels and restaurants to avoid the spread of COVID-19. Because of that, estimation of the number of closed down restaurants and hotels in Jakarta is vital for avoiding COVID-19 spread further to other people, either domestic or foreign. In this paper, the adaptive neuro-fuzzy inference system (ANFIS) is chosen as the estimation method. In estimating the number of closed restaurants and hotels using ANFIS, supporting variables such as the amount of casualties in Jakarta, the amount of casualties in Indonesia, and the amount of casualties in the world is required. As a result, ANFIS can estimate the amount of closed down restaurants and hotels approaching the target. The simulations are organized by partitioning the dataset into two parts: data of (80%) and data testing (20%). According to ANFIS simulations, ANFIS can estimate the number of closed down restaurants and hotels in training data with optimal RMSE equals 0.5324 and testing data with optimal RMSE equals 5.3198.

This is an open access article under the [CC BY-SA](#) license.



### Corresponding Author:

Teguh Herlambang

Department of Information Systems, FEBTD, Universitas Nahdlatul Ulama Surabaya (UNUSA)

Jl. Raya Jemursari 51-57, Surabaya, Indonesia

Email: teguh@unusa.ac.id

## 1. INTRODUCTION

Tourism is a vital sector for increasing the revenue of a country. People often do travel around the world for vacation, business, or other purposes. Before 2020, the number of incoming tourist worldwide were about 532,953 million in 1995, and then in 2019, they can reach 1,461 billion. International tourist arrivals have enormous economic impacts. In 2019, contribution of the sector on international tourism is approximately USD 8.9 trillion to world gross domestic product (GDP) or 0.3 per cent of the global GDP [1].

In the early march of 2020, the corona virus disease (COVID-19) has started to spread in Indonesia and become a world health problem because they have attacked many people globally, and some of them have died. This disease is firstly found in China and then spread worldwide, including in Indonesia.

COVID-19 is the disease caused by the coronavirus resembling severe acute respiratory syndrome (SARS) so that it is named SARS-CoV2. The symptoms are fever, tiredness, dry cough, sore throat, difficulty in breathing or shortness of breath. The transmission occurs in droplets through sneeze or cough from an infected person [2]. All countries implement lockdown, ban foreign visitors, and travel restrictions from other countries to reduce the spread of COVID-19. The lockdown causes some people to get reduced earning and lost their jobs. Banning foreign visitors and travel restrictions makes hotels' and lodging revenue decrease, and employers can dismiss their workers and employees [3].

The impact of COVID-19 causes the growth of economy worldwide to decrease 3% in 2020. The growth of economy in developed countries declined by 6.1%. According to the forecast, the world trade will decrease between 12.5% and 31.5% in 2020. The global inflation rate is expected to be 3% in 2020 [1].

Because this virus has spread massively in many countries, the Indonesian government has made some rules to close down the restaurants and hotels to prevent the spread of COVID-19. Jakarta is the city in Indonesia where the first victim comes and the city with the most COVID-19 positive victims. Based on Statistics Indonesia (BPS) data, the number of hotels and lodging in Indonesia are 28,243. The COVID-19 impacts the hotel and restaurant so that many of them are closed down about 49.54% [4]. Because of that, estimation of the amount of closed down restaurants and hotels in Jakarta is essential for preventing COVID-19 from spreads further to other people, either domestic or foreign. In this research, the adaptive neuro-fuzzy inference system (ANFIS) will be the estimation method.

ANFIS leverages a supervised learning algorithm and Takagi-Sugeno fuzzy inference systems. One characteristic of an adaptive network is that it consist of some adaptive nodes. In general, each node has particular purposes, and the output is influenced by the parameters and signals. In ANFIS, a hybrid method is used to train premise and consequent parameters [5]. Both ANFIS and Backpropagation are almost similar methods in training and testing the data. They work forward and backwards in training the data for producing minimal mean square error (MSE) in making predictions and using maximal accuracy in making classification [6], [7]. Furthermore, some optimization methods such as particle swarm optimization (PSO) [8], artificial bee colony (ABC) [9], or cuckoo search [10] are used to find parameters in both ANFIS and backpropagation.

In the preceding research, several forecasting methods for estimation have been applied statistically by using exponential smoothing method [11], autoregressive integrated moving average (ARIMA) for stock price estimation [12], H-infinity for estimating world crude oil price [13], Kalman filter on determining trajectory, steam temperature and water level estimation [14], stock price estimation [15], blood supply estimation [16]–[18] and fuzzy logic by using ANFIS [19]. Furthermore, backpropagation has been used in weather prediction affected by air temperature and humidity [20] and precipitation [21]. This algorithm is used in testing and training data with a particular proportion. In this paper, ANFIS estimates the number of closed down restaurants and hotels in Jakarta. In calculating the amount of closed restaurants and hotels using ANFIS, it requires supporting variables such as the amount of positively infected COVID-19 in Jakarta, the amount of dead people caused by COVID-19 in Jakarta, the amount of positively infected COVID-19 in Indonesia, the amount of dead people caused by COVID-19 in Indonesia, the amount of positively infected COVID-19 in the world, and the amount of dead people caused by COVID-19 in the world. According to simulation results, ANFIS can estimate the amount of closed down restaurants and hotels in data of training with optimal root mean square error (RMSE) equals 0.5324 and data of testing with optimal RMSE equals 5.3198. We also repeat these simulations with different membership functions.

## 2. RESEARCH METHOD

The approach used in this paper is by ANFIS. ANFIS uses a supervised learning algorithm and Takagi-Sugeno fuzzy inference system. Furthermore, ANFIS applies a hybrid method in training the data. Jang [5] proposed a hybrid method to train consequent and premise parameters. There are two sections of the hybrid method, i.e. forward and backward path [22].

### 2.1. Algorithm of adaptive neuro-fuzzy inference system (ANFIS)

Given two inputs  $x$   $y$  and a single output  $f$ . Suppose the following rules are used [5]:

Rule 1: If  $c$  is  $P_1$  and  $dis$   $Q_1$ , then  $g_1 = \alpha_1 c + \beta_1 d + \gamma_1$

Rule 2: If  $c$  is  $P_2$  and  $dis$   $Q_2$  then  $g_2 = \alpha_2 c + \beta_2 d + \gamma_2$

with  $P_1, P_2$  and  $Q_1, Q_2$  are the membership functions. Parameters  $\alpha_1, \beta_1, \gamma_1$  and  $\alpha_2, \beta_2, \gamma_2$  denote consequent parameters.

The diagram of ANFIS model is shown in Figure 1. Each layer of ANFIS has a different calculation given in (1) until (5). In the first layer, each node is the function parameter. The output of every node denotes the degree of membership value from the membership functions. The membership function is a Gaussian

Estimation of closed hotels and restaurants in Jakarta as impact of corona ... (Mohamad Yusak Anshori)

function  $\mu(y) = \exp\left(-\left(\frac{y-\gamma}{\alpha}\right)^2\right)$  or a generalized bell membership  $\mu(y) = \frac{1}{1+\left(\frac{y-\gamma}{\alpha}\right)^{2\beta}}$ . The parameters  $\alpha, \beta, \gamma$  of the membership function are called the premise parameters. In the second layer, each node is the strength of firing from the corresponding rule. The output node denotes the outcome of signal multiplications, that is sent to the following node as in (2). In the third layer, each node is the proportion between the  $i$ -th strength of firing and the total strength of firing. This outcome is defined as the normalized strength of firing as in (3). In the fourth layer, every node is the function defined as in (4). Finally, in the fifth layer, this node aggregates whole signals of the preceding nodes as in (5).

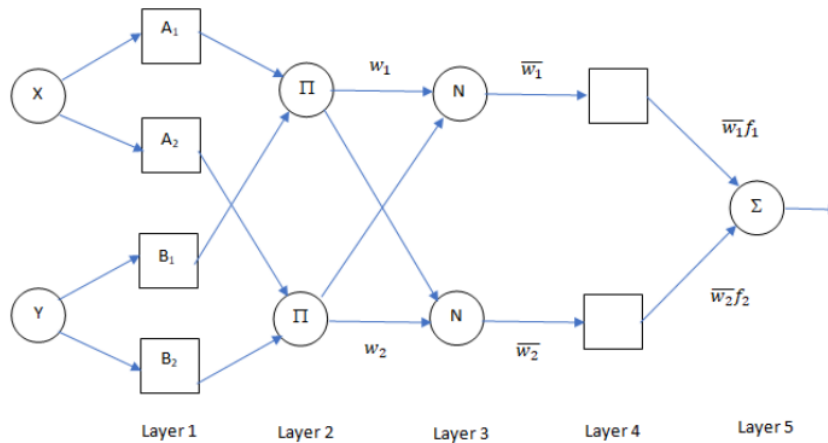

Figure 1. The diagram of ANFIS model

$$\begin{aligned} O_{1,i} &= \mu_{A_i}(y) \quad i \in \{1,2\} \\ O_{1,i} &= \mu_{B_{i-2}}(z) \quad i \in \{3,4\} \end{aligned} \tag{1}$$

$$O_{2i} = w_i = \mu_{A_i}(y) * \mu_{B_i}(z) \quad i \in \{1,2\} \tag{2}$$

$$O_{3i} = \bar{w}_i = \frac{w_i}{\sum_t w_t} \quad i \in \{1,2\} \tag{3}$$

$$O_{4i} = \bar{w}_i g_i = \bar{w}_i (\alpha_i y + \beta_i z + \gamma_i) \quad i \in \{1,2\} \tag{4}$$

$$O_5 = \sum_i \bar{w}_i g_i \tag{5}$$

**2.2. Hybrid method**

Jang [5] proposed a hybrid method for training of consequent and premise parameters. There are two sections of the hybrid method, i.e. forward and backward path. In the forward direction, signals move up to layer 4, and then the consequent parameters are obtained using the least square estimation (LSE). The rate of error when moving backwards in the backward path, and the premise parameters are obtained using gradient descent. A single level of the hybrid method is defined as an epoch. A hybrid method combining LSE and gradient descent can result in a faster convergence rate than the Backpropagation method [5].

Premise parameters  $\alpha, \beta, \gamma$  are trained and optimized using backpropagation and gradient descent: Suppose the network has  $L$  layers, and the  $k$ -th layer consists of  $\#(k)$  nodes, such that node  $i$  in the  $k$ -th layer is  $(k, i)$  where the output is  $O_i^k$ . Suppose the amount of training data is  $p$ , such that the sum of square error  $E_p$  is in (6):

$$E_p = \sum_{m=1}^{\#(L)} (T_{m,p} - O_{m,p}^L)^2 \tag{6}$$

with  $T_{m,p}$  is the target of the  $m$ -th component in the  $p$ -th data and  $O_{m,p}^L$  denotes the output of the  $m$ -th component of the layer  $L$  by the  $p$ -th data. All computations for  $N$  training data are obtained using:

$$E = \sum_{p=1}^N E_p$$

After  $E_p$  is obtained, calculate gradient descent in the  $L$ -th layer in (7). Generally, the node  $(k, i)$  is calculated using the chain rule as in (8):

$$\frac{\partial E_p}{\partial O_{i,p}^L} = -2(T_{i,p} - O_{i,p}^L) \quad (7)$$

$$\frac{\partial E_p}{\partial O_{i,p}^k} = \sum_{m=1}^{\#(k+1)} \frac{\partial E_p}{\partial O_{m,p}^{k+1}} \cdot \frac{\partial O_{m,p}^{k+1}}{\partial O_{i,p}^k} \quad (8)$$

for each  $1 \leq i \leq \#(k)$  with  $1 \leq k \leq L-1$ .

If  $\alpha$  is a premise parameter of the network, then the chain rule is defined in (9) with  $S$  is the set of nodes in which the outputs influenced by  $\alpha$ . All error value for  $N$  training data are calculated using (10). And update premise parameters using (11) and (12):

$$\frac{\partial E_p}{\partial \alpha} = \sum_{O^* \in S} \frac{\partial E_p}{\partial O^*} \cdot \frac{\partial O^*}{\partial \alpha} \quad (9)$$

$$\frac{\partial E}{\partial \alpha} = \sum_{p=1}^N \frac{\partial E_p}{\partial \alpha} \quad (10)$$

$$\Delta \alpha = -\eta \frac{\partial E}{\partial \alpha} \quad (11)$$

$$\alpha_{next} = \alpha_{curr} - \Delta \alpha = \alpha_{curr} - \left(-\eta \frac{\partial E}{\partial \alpha}\right) \quad (12)$$

with  $\eta$  denotes the rate of learning. The RMSE is calculated using:

$$RMSE = \sqrt{\frac{1}{\#(data)} \sum_{d=1}^{\#(data)} \frac{1}{m} \sum_{k=1}^m (T_{dk} - Y_{dk})^2} \quad (13)$$

with  $T_{dk}$  denotes the target and  $Y_{dk}$  denotes the outputs.

### 3. RESULTS AND DISCUSSION

Dataset is taken from the report of closed down hotels and restaurants during March 1, 2020, until April 30, 2020 (61 days), issued by Indonesian restaurants and hotels association, with the observed area in Jakarta as the first city where COVID-19 are first discovered. These data will be estimated by the ANFIS. In addition, some data about the number of COVID-19 victims (positive and dead) in Jakarta from March 1, 2020, until April 30, 2020, is obtained from the official COVID-19 Jakarta website. The number of COVID-19 victims (positive and dead) in Indonesia from March 1, 2020, until April 30, 2020, is obtained from the Ministry of Health, the Republic of Indonesia. The data of the number of COVID-19 victims (positive and dead) worldwide from March 1, 2020, until April 30, 2020, is obtained from the worldometer website. They will be used as inputs in ANFIS, with the output is the number of closed down restaurants and hotels in Jakarta from March 1, 2020, until April 30, 2020 (61 days) as estimations.

#### 3.1. Correlation test

The graph of the number of closed down restaurants and hotels from March 1, 2020, until April 30, 2020 (61 days) in Jakarta can be seen in Figure 2, where the first closed down hotels occurred on March 17, 2020, then they are followed by other hotels because the spread of COVID-19 is enormous. After that, the highest number of closed down hotels and restaurants occurred from April 1, 2020, until April 5, 2020. The next time, the graph shows a minor downtrend because some hotels and restaurants are opened again with strict health protocols.

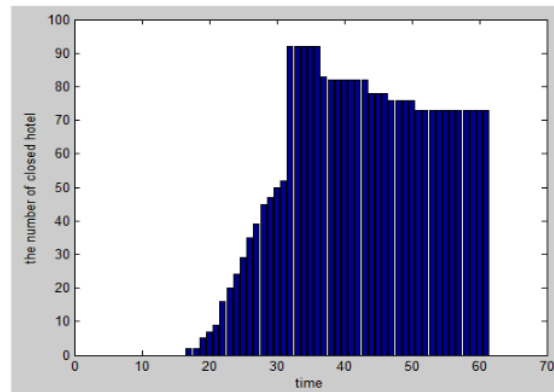

Figure 2. The number of closed hotels and restaurants

For estimating the number of closed down hotels and restaurants using ANFIS as output ( $y$ ), we need supporting variables such as the amount of positive casualties in Jakarta ( $x_1$ ), the amount of dead casualties in Jakarta ( $x_2$ ), the amount of positive casualties in Indonesia ( $x_3$ ), the amount of dead casualties in Indonesia ( $x_4$ ), the amount of positive casualties in the world ( $x_5$ ), and the amount of dead casualties in the world ( $x_6$ ). The graph of COVID-19 victims in Jakarta from March 1, 2020, until April 30, 2020, can be seen in Figure 3. There are two parts from the graph with different colours, such as the number of positive victims and dead victims. From the chart, the amount of COVID-19 positive victims and the amount of dead victims in Jakarta from March 1, 2020, until April 30, 2020, increase exponentially. For example, the number of positive victims in Jakarta can reach 4138 on April 30, 2020, and the number of dead victims in Jakarta can get 381 on April 30, 2020.

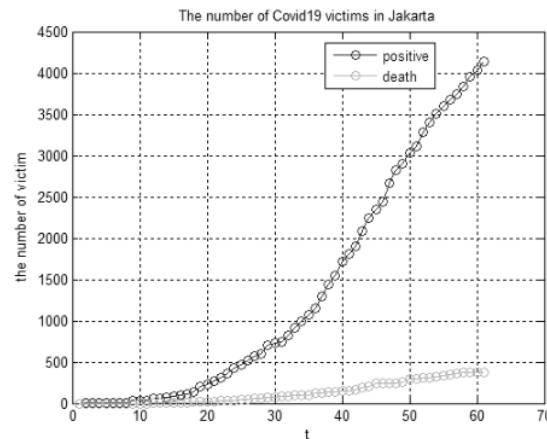

Figure 3. The number of COVID-19 victims in Jakarta

The graph of COVID-19 casualties in Indonesia from March 1, 2020, until April 30, 2020, can be seen in Figure 4. There are two parts from the graph with different colours, such as the number of positive victims and dead victims. From the graph, the amount of COVID-19 positive victims and the amount of dead victims in Indonesia from March 1, 2020, until April 30, 2020, increase exponentially. The number of positive victims in Indonesia can reach 10,118 on April 30, 2020, and the number of dead victims in Indonesia can get 792 on April 30, 2020.

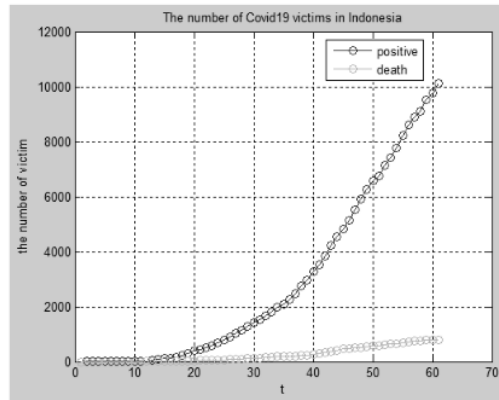

Figure 4. **1** The number of COVID-19 victims in Indonesia

The graph of the amount of COVID-19 victims in the world from March 1, 2020, until April 30, 2020, can be seen in Figure 5. There are two parts from the graph with different colours, such as the number of positive victims and dead victims. From the diagram, the amount of COVID-19 positive victims and the amount of **1** lead victims worldwide from March 1, 2020, until April 30, 2020, increase exponentially. For example, the number of positive victims in the world can reach 3,299,603 on April 30, 2020, and the amount of dead victims in the world can get 233824 on April 30, 2020.

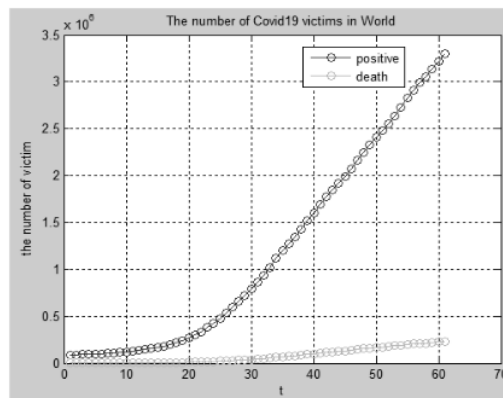

Figure 5. The number of COVID-19 victims in the world

For determining linear relationship among supporting variables such as the amount of positive casualties in Jakarta ( $x_1$ ), the amount of dead casualties in Jakarta ( $x_2$ ), the amount of positive casualties in Indonesia ( $x_3$ ), the amount of dead casualties in Indonesia ( $x_4$ ), the amount of positive casualties in the world ( $x_5$ ), the amount of dead casualties in the world ( $x_6$ ) against the amount of closed down restaurants and hotels in Jakarta as output ( $y$ ), we compute the correlation in Table 1. After that, we use the linearity test using the t-test to determine the linear relationship [23] where the t-test is in (14):

$$t = \frac{r\sqrt{n-2}}{\sqrt{1-r^2}} \quad (14)$$

with  $n$  is the amount of data and  $r$  denotes the correlation coefficient and the t-distribution having  $n - 2$  degrees of freedom.

**3** Estimation of closed hotels and restaurants in Jakarta as impact of corona ... (Mohamad Yusak Anshori)



Table 1. The correlation between some inputs against the number of closed down restaurants and hotels

	Correlation variables	Correlation value	t-test	p-value	Linear relationship
Positive (Jakarta)	The closed hotels and restaurants	0.7525	8.7764	0.0000	Yes
Dead (Jakarta)	The closed hotels and restaurants	0.7631	9.0685	0.0000	Yes
Positive (Indonesia)	The closed hotels and restaurants	0.7127	7.8050	0.0000	Yes
Dead (Indonesia)	The closed hotels and restaurants	0.7303	8.2114	0.0000	Yes
Positive (world)	The closed hotels and restaurants	0.8084	10.4165	0.0000	Yes
Dead (world)	The closed hotels and restaurants	0.7633	9.0765	0.0000	Yes

From Table 1, all the amount of positive casualties in Jakarta ( $x_1$ ), the amount of dead casualties in Jakarta ( $x_2$ ), the amount of positive casualties in Indonesia ( $x_3$ ), the amount of dead casualties in Indonesia ( $x_4$ ), the amount of positive casualties in the world ( $x_5$ ), the amount of dead casualties in the world ( $x_6$ ) have linearity relationship against the amount of closed down hotels and restaurants in Jakarta as output ( $y$ ).

### 3.2. Estimation results

Before applying the estimation method, we require to divide the data into two parts: training data and testing data. The proportion is 80% training data and 20% testing data [24]. Figure 6 displays the division between testing data (red plus marks) and training data. We make this pattern for training and testing data because the data is nonstationary. Data used in training and testing data must have resembling characteristics and properties [25].

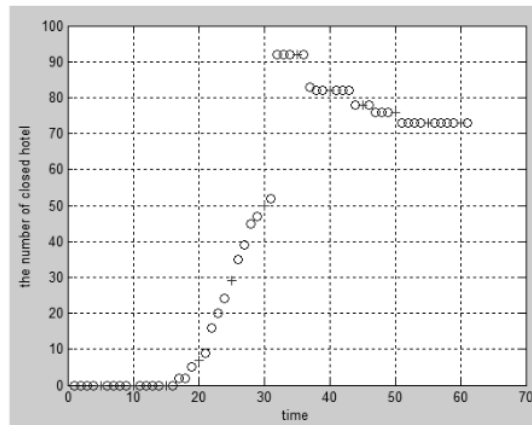

Figure 6. Data divided into two parts training data (circle) and testing data (plus)

The parameters in the simulation of ANFIS are:

- Maximum of epoch : 30
- The amount of membership functions : 2 in each input
- The amount of rules : 64
- The amount of linear parameters (consequents) : 448
- The amount of nonlinear parameters (premises) : 36

The simulation results of ANFIS are shown in Figures 7 to 10. Two membership functions are used: the circle curve denotes 'small' and the green curve denotes 'large'. Figure 7 displays the optimized membership functions of inputs such as the amount of positive casualties in Jakarta, the amount of dead casualties in Jakarta, the amount of positive casualties in Indonesia, the amount of dead casualties in Indonesia, the amount of positive casualties in the world, and the amount of dead casualties in the world. Each membership function leverages a generalized bell (gbell) containing three nonlinear parameters. Figure 8 displays the convergence process of RMSE. In the early epoch, and the RMSE was pretty big. During the optimization process, the RMSE is decreased to 0.5324. Figure 9 displays estimation results (the number of closed down restaurants and hotels) on training data. It seems that there are the comparison and error between the target and the output. From the training process until the 30 epoch, it is obtained optimal

ANFIS parameters. Then, optimal ANFIS parameters are used in testing data. Figure 10 displays estimation results (the number of closed down restaurants and hotels) on testing data.

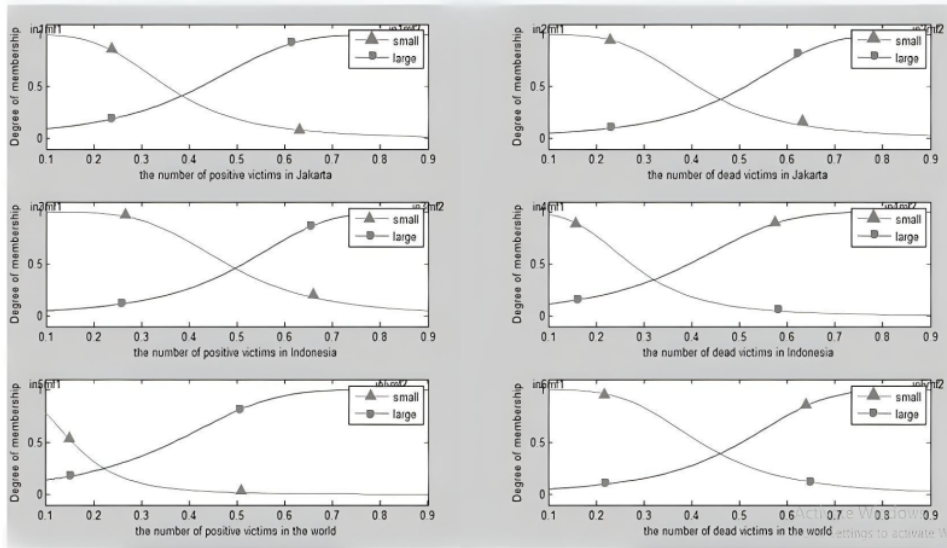

Figure 7. Optimal membership function of ANFIS

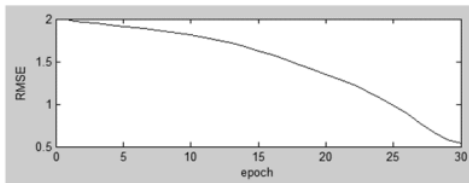

Figure 8. Convergence process of ANFIS

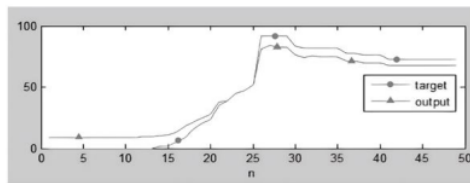

Figure 9. Estimation result on training data of the amount of closed down hotels and restaurants in Jakarta

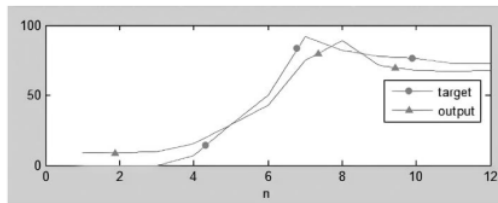

Figure 10. Estimation result on testing data of the amount of closed down hotels and restaurants in Jakarta

From the simulation in Figure 9 and Figure 10, we achieve the estimation with the RMSE in (13) are:

- Data for training : 0.5324
- Data for testing : 5.3198

They seem that error on the testing data is more significant than on the training data.

We replay the simulations five times using other membership functions such as gaussmf resembling normal or gaussian distribution shape, trapmf using trapezoidal shape function, trimf using triangular shape function, pimf, and dsigmf. Finally, the results are displayed in Table 2, i.e. RMSE on ANFIS with different membership function with maximum epoch is 30. The best membership function for training data is dsigmf with an RMSE equals 0.4422, while the best membership function for testing data is Trapmf with an RMSE equals 3.0560. They seem that errors on the testing data are more significant than on the training data in all five membership functions.

Table 2. The RMSE on ANFIS with other membership functions

Membership function	Max epoch	RMSE on training data	RMSE on testing data
Gaussmf	30	0.5375	4.8326
Trapmf	30	2.1666	3.0560
Trimf	30	1.8291	3.9111
Pimf	30	2.1729	8.4132
Dsigmf	30	0.4422	6.4076

#### 4. CONCLUSION

In estimating the number of closed down restaurants and hotels using ANFIS, it is required supporting variables such as the amount of positive casualties in Jakarta, the amount of dead casualties in Jakarta, the amount of positive casualties in Indonesia, the amount of dead casualties in Indonesia, the amount of positive casualties in the world, and the amount of dead casualties in the world. ANFIS can estimate the number of closed down restaurants and hotels approaching the target. Simulations are conducted by dividing the dataset into two parts: training data (80%) and testing data (20%). From ANFIS computations, ANFIS can estimate the amount of closed down restaurants and hotels in data of training with optimal RMSE equals 0.5324 and data of testing with optimal RMSE equals 5.3198. The improvements of this research are making estimation and classification the results by data mining and machine learning techniques.

#### ACKNOWLEDGEMENTS

This work was fully supported by the LPPM-University of Nahdlatul Ulama Surabaya (UNUSA).



#### REFERENCES

- [1] T. Haryanto, "Editorial: COVID-19 pandemic and international tourism demand," *Journal of Developing Economies*, vol. 5, no. 1, p. 1, Jun. 2020, doi: 10.20473/jde.v5i1.19767.
- [2] K. I. Khan, A. Niazi, A. Nasir, M. Hussain, and M. I. Khan, "The Effect of COVID-19 on the Hospitality Industry: The Implication for Open Innovation," *Journal of Open Innovation: Technology, Market, and Complexity*, vol. 7, no. 1, p. 30, Jan. 2021, doi: 10.3390/joitmc7010030.
- [3] O. Anguera-Torrell, J. P. Aznar-Alarcón, and J. Vives-Perez, "COVID-19: hotel industry response to the pandemic evolution and to the public sector economic measures," *Tourism Recreation Research*, vol. 46, no. 2, pp. 148–157, Apr. 2021, doi: 10.1080/02508281.2020.1826225.
- [4] N. P. L. A. Puspita, I. P. Astawa, and I. G. Mudana, "Hotel strategy in facing the COVID-19 pandemic (The Westin Resort Nusa Dua Experience)," *International Journal of Global Tourism*, vol. 2, no. 1, pp. 28–39, 2021.
- [5] J.-S. R. Jang, "ANFIS: adaptive-network-based fuzzy inference system," *IEEE Transactions on Systems, Man, and Cybernetics*, vol. 23, no. 3, pp. 665–685, 1993, doi: 10.1109/21.256541.
- [6] M. Y. Anshori, D. Rahmalia, and T. Herlambang, "Comparison backpropagation (BP) and learning vector quantification (LVQ) on classifying price range of smartphone in market," *Journal of Physics: Conference Series*, vol. 1836, no. 1, p. 12040, Mar. 2021, doi: 10.1088/1742-6596/1836/1/012040.
- [7] D. Rahmalia, M. S. Pradana, and T. Herlambang, "Klasifikasi multi output pada harga smartphone menggunakan learning vector quantization (LVQ) dan backpropagation (BP)," *Systemic: Information System and Informatics Journal*, vol. 6, no. 2, pp. 14–19, Jan. 2021, doi: 10.29080/systemic.v6i2.967.
- [8] R. Rajkumar, A. James Albert, and D. Chandrakala, "Weather forecasting using fuzzy neural network (FNN) and hierarchy particle swarm optimization algorithm (HPSO)," *Indian Journal of Science and Technology*, vol. 8, no. 12, Jun. 2015, doi: 10.17485/ijst/2015/v8i12/52708.
- [9] D. Karaboğa and E. Kaya, "Training ANFIS by using the artificial bee colony algorithm," *Turkish Journal of Electrical Engineering and Computer Sciences*, vol. 25, pp. 1669–1679, 2017, doi: 10.3906/elk-1601-240.
- [10] M. Y. Anshori, D. Rahmalia, T. Herlambang, and D. F. Karya, "Optimizing adaptive neuro fuzzy inference system (ANFIS) parameters using cuckoo search (Case study of world crude oil price estimation)," *Journal of Physics: Conference Series*, vol. 1836, no. 1, p. 12041, Mar. 2021, doi: 10.1088/1742-6596/1836/1/012041.
- [11] D. Rahmalia, "Estimation of exponential smoothing parameter on pesticide characteristic forecast using ant colony optimization (ACO)," *EKSAKTA: Journal of Sciences and Data Analysis*, pp. 56–63, Mar. 2018, doi: 10.20885/eksakta.vol18.iss1.art6.
- [12] D. C. Montgomery, C. L. Jennings, and M. Kulahci, *Introduction to time series analysis and forecasting*. Wiley, 2015.
- [13] M. Y. Anshori, T. Herlambang, D. F. Karya, D. Rahmalia, and P. A. Inawati, "H-Infinity for world crude oil price estimation,"



- Journal of Physics: Conference Series*, vol. 1563, no. 1, p. 12016, Jun. 2020, doi: 10.1088/1742-6596/1563/1/012016.
- [14] T. Herlambang, Z. Mufarrikhoh, D. F. Karya, and D. Rahmalia, "Estimation of water level and steam temperature using ensemble Kalman filter square root (EnKF-SR)," *Journal of Physics: Conference Series*, vol. 1008, p. 12026, Apr. 2018, doi: 10.1088/1742-6596/1008/1/012026.
- [15] D. F. Karya, P. Katias, T. Herlambang, and D. Rahmalia, "Development of Unscented Kalman Filter Algorithm for stock price estimation," *Journal of Physics: Conference Series*, vol. 1211, p. 12031, Apr. 2019, doi: 10.1088/1742-6596/1211/1/012031.
- [16] A. Muhith, T. Herlambang, Ihamah, and D. Rahmalia, "Estimation of thrombocyte concentrate (TC) and whole blood (WB) using unscented Kalman filter," *International Journal of Advanced Science and Technology*, vol. 29, no. 8, pp. 25–32, 2020.
- [17] A. Muhith, T. Herlambang, M. Y. Anshori, R. Rizqina, D. Rahmalia, and Hemanto, "Estimation of whole blood (WB) and anti-hemophilate factor using extended kalman filter in PMI Surabaya," *Journal of Physics: Conference Series*, vol. 1538, no. 1, p. 12034, May 2020, doi: 10.1088/1742-6596/1538/1/012034.
- [18] A. Muhith, T. Herlambang, A. Haris, and D. Rahmalia, "Estimation of whole blood (WB) using unscented kalman filter in Surabaya," *IOP Conference Series: Materials Science and Engineering*, vol. 874, no. 1, p. 12028, Jun. 2020, doi: 10.1088/1757-899X/874/1/012028.
- [19] L. Al-Matarnah, A. Sheta, S. Bani-Ahmad, J. Alshaer, and I. Al-oqily, "Development of temperature-based weather forecasting models using neural networks and fuzzy logic," *International Journal of Multimedia and Ubiquitous Engineering*, vol. 9, no. 12, pp. 343–366, Dec. 2014, doi: 10.14257/ijmue.2014.9.12.31.
- [20] D. Rahmalia *et al.*, "Comparison between neural network (NN) and adaptive neuro fuzzy inference system (ANFIS) on sunlight intensity prediction based on air temperature and humidity," *Journal of Physics: Conference Series*, vol. 1538, no. 1, p. 12044, May 2020, doi: 10.1088/1742-6596/1538/1/012044.
- [21] J. Lu, S. Xue, X. Zhang, S. Zhang, and W. Lu, "Neural Fuzzy Inference System-Based Weather Prediction Model and Its Precipitation Predicting Experiment," *Atmosphere*, vol. 5, no. 4, pp. 788–805, Nov. 2014, doi: 10.3390/atmos5040788.
- [22] W. Suparta and K. M. Alhasa, *Modeling of tropospheric delays using ANFIS*. Cham: Springer International Publishing, 2016.
- [23] R. E. Walpole, R. H. Myers, S. L. Myers, and K. Ye, *Probability and statistics for engineers and scientists*. Boston: Prentice Hall, 2012.
- [24] J. Han, J. Pei, and M. Kamber, *Data mining concepts and techniques*. Elsevier, 2011.
- [25] T. Herlambang, D. Rahmalia, and T. Yulianto, "Particle Swarm Optimization (PSO) and Ant Colony Optimization (ACO) for optimizing PID parameters on Autonomous Underwater Vehicle (AUV) control system," *Journal of Physics: Conference Series*, vol. 1211, p. 12039, Apr. 2019, doi: 10.1088/1742-6596/1211/1/012039.

## BIOGRAPHIES OF AUTHORS





**Mohamad Yusak Anshori**    is currently Lecturer at the Department of Management, Nahdlatul Ulama Surabaya University (UNUSA) Surabaya, Indonesia. He received his Bachelor Degree in International Relations from Gadjah Mada University Yogyakarta. His Master and Doctoral Degree in Management from Airlangga University Surabaya. His area of interest is Strategic Management, Marketing, and Tourism Hospitality. He can be contacted at email: yusak.anshori@unusa.ac.id.







**Teay Shawyun**    is currently Associate Professor in Strategic Management and Independent Education and Performance System Consultant. He received his Bachelor Degree in Business Computer from Assumption University University. Master in Finance and International Business from Sasin Graduate Institute of Business Administration Chulalongkorn University. Doctor of Philosophy in Technology Management from Asian Institute of Technology. His area of interest is Strategic Management, Independent Education, Performance System. He can be contacted at email: jerry182122@yahoo.com.







**Dennis Villasar Madrigal**    is currently President of the Philippine Association of Catholic Religious Educators (PACRE), Inc. He is also a member of the Philippine Society for Educational Research and Evaluation and Philippine Association for Graduate Education Region VII. He earned his Bachelor of Arts in Classical Philosophy at Casiciaco Recoletos Seminary in 1996 and Master of Arts in Education major in Religious Studies at La Consolation College-Bacolod in 2009. He received his PhD major in Educational Management in 2014 from the University of Negros Occidental-Recoletos. As a CHED scholar, he is now pursuing his PhD in Education major in Research and Evaluation at Silliman University, Dumaguete City. He can be contacted at email: denis\_madrigal@yahoo.com.







**Dinita Rahmalia**     is currently lecturer at Mathematics Department, Universitas Islam Darul Ulum Lamongan, Indonesia. Received Bachelor Degree at Institute of Technology Sepuluh Nopember (ITS) and Master Degree at Institute of Technology Bandung (ITB) both Mathematics Department. She can be contacted at email: dinitarahmalia@gmail.com.







**Fajar Annas Susanto**     is currently vice-Dean Faculty of Business Economics and Digital Technology (FEBTD) and lecturer at Information System Department, Nahdlatul Ulama Surabaya University (UNUSA) Surabaya, Indonesia. Received Bachelor Degree at Dinamika University (STIKOM Surabaya) and Master Degree at Institute of Technology Sepuluh Nopember (ITS) both Information System Department. Area of research are IT/IS Evaluation and Project Management, IT Governance. He can be contacted at email: fajar@unusa.ac.id.



**Teguh Herlambang**     is currently Lecturer at the Department of Information System, Nahdlatul Ulama Surabaya University (UNUSA) Surabaya, Indonesia. He received his B.Sc and M.Sc. degree from Department of Mathematics at Institute of Technology Sepuluh Nopember (ITS) in 2010 and 2012. He receive his Ph.D degree from Department of Ocean Engineering at Institute of Technology Sepuluh Nopember (ITS). He is currently is a Head of Research Department of FEBTD UNUSA, also assigned as researcher in Center of Excellence for Mechatronics and Industrial Automation (PUI-PT MIA-RC ITS) Kemenristekdikti. His area of interest is modelling, navigation, guidance and control of dynamics system. He can be contacted at email: teguh@unusa.ac.id.



**Dieky Adzkiya**     is an Assistant Professor in the Department of Mathematics and a member of Mechatronics and Industrial Automation Research Center, both at Institut Teknologi Sepuluh Nopember, Indonesia. He received the B.Sc. degree in September 2005 and the M.Sc. degree in October 2008, both in Mathematics from the Institut Teknologi Sepuluh Nopember, Surabaya, Indonesia. He received the Ph.D. degree in Systems and Control in October 2014 and after that he continued as a postdoctoral researcher until June 2015, both at the Delft Center for Systems and Control, Delft University of Technology, Delft, The Netherlands. His research interests are in the analysis and verification of max-plus-linear systems and in their applications. He can be contacted at email: dieky@matematika.its.ac.id.

# Estimation of closed hotels and restaurants in Jakarta as impact of corona virus disease spread using adaptive neuro fuzzy inference system

## ORIGINALITY REPORT

9%

SIMILARITY INDEX

7%

INTERNET SOURCES

9%

PUBLICATIONS

4%

STUDENT PAPERS

## PRIMARY SOURCES

1 [journal.umg.ac.id](http://journal.umg.ac.id) 5%  
Internet Source

2 M Y Anshori, D Rahmalia, T Herlambang, D F Karya. "Optimizing Adaptive Neuro Fuzzy Inference System (ANFIS) parameters using Cuckoo Search (Case study of world crude oil price estimation)", Journal of Physics: Conference Series, 2021 2%  
Publication

3 [researcher.life](http://researcher.life) 2%  
Internet Source

Exclude quotes On

Exclude matches < 2%

Exclude bibliography On