

SURAT KETERANGAN

Nomor: 941/UNUSA-LPPM/Adm-I/VI/2022

Lembaga Penelitian dan Pengabdian Kepada Masyarakat (LPPM) Universitas Nahdlatul Ulama Surabaya menerangkan telah selesai melakukan pemeriksaan duplikasi dengan membandingkan artikel-artikel lain menggunakan perangkat lunak **Turnitin** pada tanggal 28 Desember 2022.

Judul : *Estimation of Closed Hotels and Restaurants in Jakarta as Impact of Corona Virus Disease (Covid-19) Spread Using Adaptive Neuro Fuzzy Inference System*

Penulis : Mohamad Yusak Anshori, Teay Shawyun, Denis Fidita Karya, Madrigal, Dinita Rahmalia, Fajar Annas Susanto, Teguh Herlambang, Dieky Adzkiya

No. Pemeriksaan : 2022.06.10.303

Dengan Hasil sebagai Berikut:

Tingkat Kesamaan diseluruh artikel (*Similarity Index*) yaitu 20%

Demikian surat keterangan ini dibuat untuk digunakan sebagaimana mestinya

Surabaya, 10 Juni 2022

Ketua LPPM,



Achmad Syafiuddin, Ph.D.

NPP. 20071300

Estimation of Closed Hotels and Restaurants in Jakarta as Impact of Corona Virus Disease (Covid-19) Spread Using Adaptive Neuro Fuzzy Inference System

by Teguh Herlambang 10

Submission date: 28-Dec-2021 08:54AM (UTC+0700)

Submission ID: 1735996389

File name: coba_parfarase_IJAI_2021-12-27.pdf (890.07K)

Word count: 4588

Character count: 23916

Estimation of Closed Hotels and Restaurants in Jakarta as Impact of Corona Virus Disease (Covid-19) Spread Using Adaptive Neuro Fuzzy Inference System

Mohamad Yusak Anshori¹, Teay Shawyun², Dennis V. Madrigal³, Dinita Rahmalia⁴, Fajar Annas Susanto⁵, Teguh Herlambang⁵, Dieky Adzkiya⁶

¹Department of Management, University of Nahdlatul Ulama Surabaya (UNUSA), Indonesia

²Suwarnabhumi Vocational Institute of Technology, Thailand

³University of N26os Occidental-Recoletos, Philippines

⁴Department of Mathematics, University of Islam Darul Ulum Lamongan, Indonesia

⁵Department of Information Systems, University of Nahdlatul Ulama Surabaya (UNUSA), Indonesia

⁶Department of Mathematics, Institut Teknologi Sepuluh Nopember, Indonesia

Article Info

Article history:

Received month dd, yyyy

Revised month dd, yyyy

Accepted month dd, yyyy

Keywords:

First keyword

Second keyword

Third keyword

Fourth keyword

Fifth keyword

ABSTRACT

Covid-19 or Corona Virus Disease have become a world health problem because they have attacked many people worldwide, some of whom have died. Because this virus has spread massively in almost all countries, including Indonesia, the Indonesian government made some policies and rules to close down the hotels and restaurants to avoid the spread of Covid-19. Because of that, estimation of the number of closed down restaurants and hotels in Jakarta is vital for avoiding Covid-19 spreads further to other people, either domestic or foreign. In this paper, the Adaptive Neuro-Fuzzy Inference System (ANFIS) is chosen as the estimation method. In estimating the number of closed restaurants and hotels using ANFIS, supporting variables such as the amount of casualties in Jakarta, the amount of casualties in Indonesia, and the amount of casualties in the world is required. As a result, ANFIS can estimate the amount of closed down restaurants and hotels approaching the target. The simulations are organized by partitioning the dataset into two parts: data of (80%) and data testing (20%). According to ANFIS simulations, ANFIS can estimate the number of closed down restaurants and hotels in training data with optimal RMSE equals 0.5324 and testing data with optimal RMSE equals 5.3198. We also repeat these simulations with different membership functions.

6

Corresponding Author:

Teguh Herlambang

Study Program of Information Systems, FEBTD

Universitas Nahdlatul Ulama Surabaya (UNUSA),

Jl. Raya Jemursari 51-57, Surabaya, Indonesia.

Email: teguh@unusa.ac.id

1. INTRODUCTION

Tourism is a vital sector for increasing the revenue of a country. People often do travel around the world for vacation, business, or other purposes. Before 2020, the number of incoming tourist worldwide were about 532.953 million in 1995, and then in 2019, they can reach 1,461 billion. International tourist arrivals have enormous economic impacts. In 2019, contribution of the sector on international tourism is approximately USD 8.9 trillion to world GDP or 0.3 per cent of the global GDP [1].

In the early march of 2020, the Corona Virus Disease (Covid-19) has started to spread in Indonesia and become a world health problem because they have attacked many people globally, and some of them have died. This disease is firstly found in China and then spread worldwide, including in Indonesia. Covid-19 is the disease caused by the Coronavirus resembling SARS so that it is named SARS-CoV2. The symptoms are fever, tiredness, dry cough, sore throat, difficulty in breathing or shortness of breath. The transmission occurs in

Journal homepage: <http://ijai.iaescore.com>

droplets through sneeze or cough from an infected person [2]. All countries implement lockdown, ban foreign visitors, and travel restrictions from other countries to reduce the spread of Covid-19. The lockdown causes some people to get reduced earning and lost their jobs. Banning foreign visitors and travel restrictions makes hotels' and lodging revenue decrease, and employers can dismiss their workers and employees [3].

The impact of Covid-19 causes the growth of economy worldwide to decrease 3 per cent in 2020. The growth of economy in developed countries declined by 4.8 per cent. According to the forecast, the world trade will decrease between 12.5 per cent and 31.5 per cent in 2020. The global inflation rate is expected to be 3 per cent in 2020 [1].

Because this virus has spread massively in many countries, the Indonesian government has made some rules to close down the restaurants and hotels to prevent the spread of Covid-19. Jakarta is the city in Indonesia where the first victim comes and the city with the most Covid-19 positive victims. Based on BPS (Badan Pusat Statistik) data, the number of hotels and lodging in Indonesia are 28,243. The Covid-19 impacts the hotel and restaurant so that many of them are closed down about 49.54 per cent [4]. Because of that, estimation of the amount of closed down restaurants and hotels in Jakarta is essential for preventing Covid-19 from spreads further to other people, either domestic or foreign. In this research, the Adaptive Neuro-Fuzzy Inference System (ANFIS) will be the estimation method.

Adaptive Neuro-Fuzzy Inference System (ANFIS) leverages a supervised learning algorithm and Takagi-Sugeno fuzzy inference systems. One characteristic of an adaptive network is that it consist of some adaptive nodes. In general, each node has particular purposes, and the output is influenced by the parameters and signals. In ANFIS, a hybrid method is used to train premise and consequent parameters [5]. Both ANFIS and Backpropagation are almost similar methods in training and testing the data. They work forward and backwards in training the data for producing minimal Mean Square Error (MSE) in making prediction and using maximal accuracy in making classification [6,7]. Furthermore, some optimization methods such as Particle Swarm Optimization (PSO) [8], Artificial Bee Colony (ABC) [9], or Cuckoo Search [10] are used to find parameters in both ANFIS and Backpropagation.

In the preceding research, several forecasting methods for estimation have been applied statistically by using exponential smoothing method [11], Autoregressive Integrated Moving Average (ARIMA) for stock price estimation [12], H-infinity for estimating world crude oil price [13], Kalman Filter on determining trajectory, steam temperature and water level estimation [14], stock price estimation [15], blood supply estimation [16,17,18] and fuzzy logic by using Adaptive Neuro-Fuzzy Inference System [19]. Furthermore, backpropagation has been used in weather prediction affected by air temperature and humidity [20] and precipitation [21]. This algorithm is used in testing and training data with a particular proportion. In this paper, ANFIS estimates the number of closed down restaurants and hotels in Jakarta. In calculating the amount of closed restaurants and hotels using ANFIS, it requires supporting variables such as the amount of positively infected covid-19 in Jakarta, the amount of dead people caused by covid-19 in Jakarta, the amount of positively infected covid-19 in Indonesia, the amount of dead people caused by covid-19 in Indonesia, the amount of positively infected covid-19 in the world, and the amount of dead people caused by covid-19 in the world.

According to simulation results, ANFIS can estimate the amount of closed down restaurants and hotels in data of training with optimal RMSE equals 0.5324 and data of testing with optimal RMSE equals 5.3198. We also repeat these simulations with different membership functions.

2. RESEARCH METHOD

The approach used in this paper is by Adaptive Neuro-Fuzzy Inference System (ANFIS). ANFIS uses a supervised learning algorithm and Takagi-Sugeno fuzzy inference system furthermore, ANFIS applies a hybrid method in training the data. In 1993, Jang proposed a hybrid method to train consequent and premise parameters. There are two sections of the hybrid method, i.e. forward and backward path [22].

2.1. Algorithm of Adaptive Neuro-Fuzzy Inference System (ANFIS)

Given two inputs x y and a single output f . Suppose the following rules are used [5]:

Rule 1: If c is P_1 and d is Q_1 , then $g_1 = \alpha_1 c + \beta_1 d + \gamma_1$

Rule 2: If c is P_2 and d is Q_2 then $g_2 = \alpha_2 c + \beta_2 d + \gamma_2$

with P_1, P_2 and Q_1, Q_2 are the membership functions. Parameters $\alpha_1, \beta_1, \gamma_1$ and $\alpha_2, \beta_2, \gamma_2$ denote consequent parameters.

Each layer of ANFIS has a different calculation given in (1) until (5). In the first layer, each node is the function parameter. The output of every node denotes the degree of membership value from the membership functions.

The membership function is a Gaussian function $\mu(y) = \exp\left(-\left(\frac{y-\gamma}{\alpha}\right)^2\right)$ or a generalized bell

membership $\mu(y) = \frac{1}{1 + \left(\frac{y-\gamma}{\alpha}\right)^{2\beta}}$. The parameters α, β, γ of the membership function are called the

premise parameters. In the second layer, each node is the strength of firing from the corresponding rule. The output node denotes the outcome of signal multiplications, that is sent to the following node as in (2). In the third layer, each node is the proportion between the i -th strength of firing and the total strength of firing. This outcome is defined as the normalized strength of firing as in (3). In the fourth layer, every node is the function defined as in (4). Finally, in the fifth layer, this node aggregates whole signals of the preceding nodes as in (5).

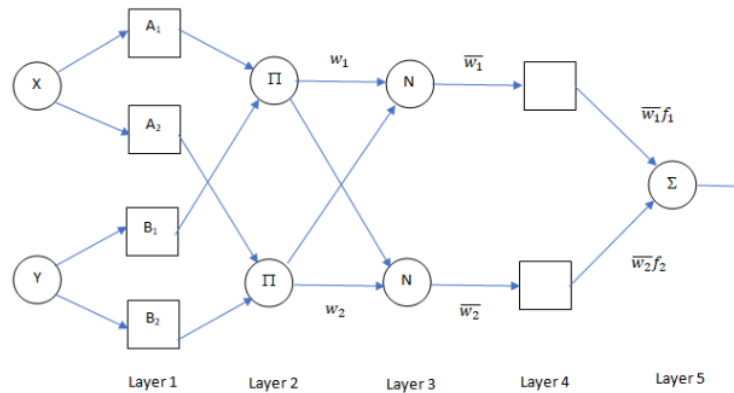

Figure 1. The diagram of ANFIS Model

$$O_{1,i} = \mu_{A_i}(y) \quad i \in \{1,2\} \quad (1)$$

$$O_{1,i} = \mu_{B_{i-2}}(z) \quad i \in \{3,4\} \quad (2)$$

$$O_{2i} = w_i = \mu_{A_i}(y) * \mu_{B_i}(z) \quad i \in \{1,2\} \quad (3)$$

$$O_{3i} = \bar{w}_i = \frac{w_i}{\sum_i w_i} \quad i \in \{1,2\} \quad (4)$$

$$O_{4i} = \bar{w}_i g_i = \bar{w}_i (\alpha_i y + \beta_i z + \gamma_i) \quad i \in \{1,2\} \quad (5)$$

$$O_5 = \sum_i \bar{w}_i g_i$$

2.2. Hybrid Method

In 1993, Jang proposed a hybrid method for training of consequent and premise parameters. There are two sections of the hybrid method, i.e. forward and backward path. In the forward direction, signals move up to layer 4, and then the consequent parameters are obtained using the least square estimation (LSE). The rate of error when moving backwards in the backward path, and the premise parameters are obtained using gradient descent. A single level of the hybrid method is defined as an epoch. A hybrid method combining LSE and gradient descent can result in a faster convergence rate than the Backpropagation method [5].

Premise parameters α, β, γ are trained and optimized using backpropagation and gradient descent:

Suppose the network has L layers, and the k -th layer consists of $\#(k)$ nodes, such that node i in the k -th layer is (k, i) where the output is O_i^k . Suppose the amount of training data is p , such that the sum of square error E_p is in (6).

$$E_p = \sum_{m=1}^{\#(L)} (T_{m,p} - O_{m,p}^L)^2 \quad (6)$$

with $T_{m,p}$ is the target of the m -th component in the p -th data and $O_{m,p}^L$ denotes the output of the m -th component of the layer L by the p -th data. All computations for N training data are obtained using

$$E = \sum_{p=1}^N E_p$$

After E_p is obtained, calculate gradient descent in the L -th layer in (7). Generally, the node (k, i) is calculated using the chain rule as in (8).

$$\frac{\partial E_p}{\partial O_{i,p}^L} = -2(T_{i,p} - O_{i,p}^L) \quad (7)$$

$$\frac{\partial E_p}{\partial O_{i,p}^k} = \sum_{m=1}^{\#(k+1)} \frac{\partial E_p}{\partial O_{m,p}^{k+1}} \cdot \frac{\partial O_{m,p}^{k+1}}{\partial O_{i,p}^k} \quad (8)$$

for each $1 \leq i \leq \#(k)$ with $1 \leq k \leq L-1$

If α is a premise parameter of the network, then the chain rule is defined in (9) with S is the set of nodes in which the outputs influenced by α . All error value for N training data are calculated using (10). And update premise parameters using (11) and (12).

$$\frac{\partial E_p}{\partial \alpha} = \sum_{O^* \in S} \frac{\partial E_p}{\partial O^*} \cdot \frac{\partial O^*}{\partial \alpha} \quad (9)$$

$$\frac{\partial E}{\partial \alpha} = \sum_{p=1}^N \frac{\partial E_p}{\partial \alpha} \quad (10)$$

$$\Delta \alpha = -\eta \frac{\partial E}{\partial \alpha} \quad (11)$$

$$\alpha_{next} = \alpha_{curr} - \Delta \alpha = \alpha_{curr} - \left(-\eta \frac{\partial E}{\partial \alpha} \right) \quad (12)$$

with η denotes the rate of learning.

The root of mean square error (RMSE) is calculated using :

$$RMSE = \sqrt{\frac{1}{\#(data)} \sum_{d=1}^{\#(data)} \frac{1}{m} \sum_{k=1}^m (T_{dk} - Y_{dk})^2} \quad (13)$$

with T_{dk} denotes the target and Y_{dk} denotes the outputs.

3. RESULTS AND DISCUSSION

Dataset is taken from the report of closed down hotels and restaurants during March 1, 2020, until April 30, 2020 (61 days), issued by Indonesian Restaurants and Hotels Association, with the covered area in Jakarta as the first city where Covid-19 are first discovered. These data will be estimated by the Adaptive Neuro-Fuzzy Inference System (ANFIS).

In addition, some data about the number of Covid-19 victims (positive and dead) in Jakarta from March 1, 2020, until April 30, 2020, is obtained from the official Covid-19 Jakarta website. The number of Covid-19 victims (positive and dead) in Indonesia from March 1, 2020, until April 30, 2020, is obtained from the Ministry of Health, the Republic of Indonesia. The data of the number of Covid-19 victims (positive and dead) worldwide from March 1, 2020, until April 30, 2020, is obtained from the Worldometer website. They will be used as inputs in ANFIS, with the output is the number of closed down restaurants and hotels in Jakarta from March 1, 2020, until April 30, 2020 (61 days) as estimations.

3.1. Correlation Test

The graph of the number of closed down restaurants and hotels from March 1, 2020, until April 30, 2020 (61 days) in Jakarta can be seen in Figure 2, where the first closed down hotels occurred on March 17, 2020, then they are followed by other hotels because the spread of Covid-19 is enormous. After that, the highest number of closed down hotels and restaurants occurred from April 1, 2020, until April 5, 2020. The next time, the graph shows a minor downtrend because some hotels and restaurants are opened again with strict health protocols.

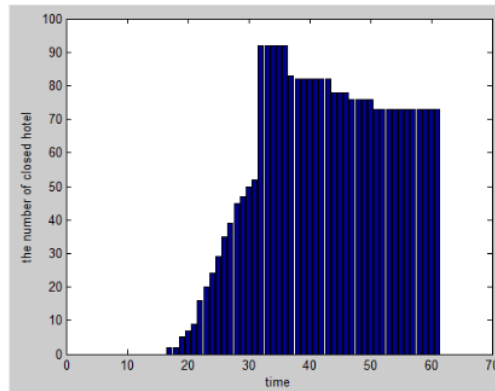

Figure 2. The number of closed hotels and restaurants

For estimating the number of closed down hotels and restaurants using ANFIS as output (y), we need supporting variables such as the amount of positive casualties in Jakarta (x_1), the amount of dead casualties in Jakarta (x_2), the amount of positive casualties in Indonesia (x_3), the amount of dead casualties in Indonesia (x_4), the amount of positive casualties in the world (x_5), and the amount of dead casualties in the world (x_6).

The graph of Covid-19 victims in Jakarta from March 1, 2020, until April 30, 2020, can be seen in Figure 3. There are two parts from the graph with different colours, such as the number of positive victims and dead victims. From the chart, the amount of Covid-19 positive victims and the amount of dead victims in Jakarta from March 1, 2020, until April 30, 2020, increase exponentially. For example, the number of positive victims in Jakarta can reach 4138 on April 30, 2020, and the number of dead victims in Jakarta can get 381 on April 30, 2020.

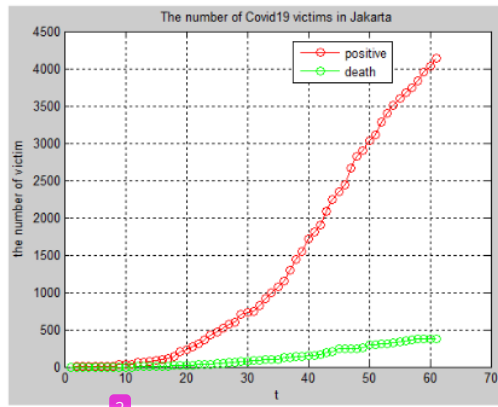

Figure 3. The number of Covid-19 victims in Jakarta

The graph of Covid-19 casualties in Indonesia from March 1, 2020, until April 30, 2020, can be seen in Figure 4. There are two parts from the graph with different colours, such as the number of positive victims and dead victims. From the graph, the amount of Covid-19 positive victims and the amount of dead victims in Indonesia from March 1, 2020, until April 30, 2020, increase exponentially. The number of positive victims in Indonesia can reach 10118 on April 30, 2020, and the number of dead victims in Indonesia can get 792 on April 30, 2020.

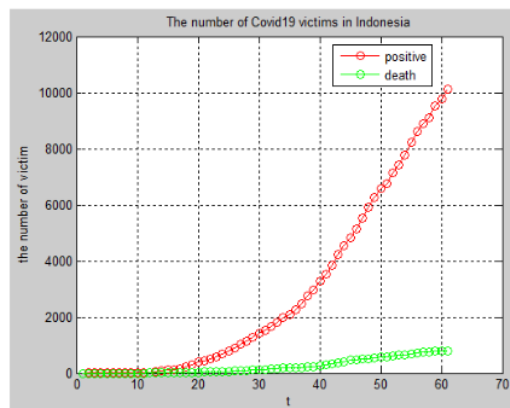

Figure 4. The number of Covid-19 victims in Indonesia

The graph of the amount of Covid-19 victims in the world from March 1, 2020, until April 30, 2020, can be seen in Figure 5. There are two parts from the graph with different colours, such as the number of positive victims and dead victims. From the diagram, the amount of Covid-19 positive victims and the amount of dead victims worldwide from March 1, 2020, until April 30, 2020, increase exponentially. For example, the number of positive victims in the world can reach 3299603 on April 30, 2020, and the amount of dead victims in the world can get 233824 on April 30, 2020.

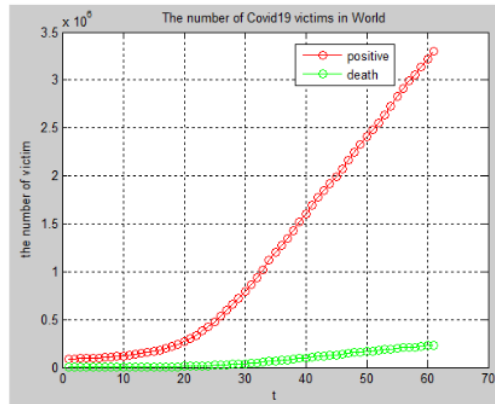

Figure 5. The number of Covid-19 victims in the world

For determining linear relationship among supporting variables such as the amount of positive casualties in Jakarta (x_1), the amount of dead casualties in Jakarta (x_2), the amount of positive casualties in Indonesia (x_3), the amount of dead casualties in Indonesia (x_4), the amount of positive casualties in the world (x_5), the amount of dead casualties in the world (x_6) against the amount of closed down restaurants and hotels in Jakarta as output (y), we compute the correlation in Table 1. After that, we use the linearity test using the t-test to determine the linear relationship [23] where the t-test is in (14).

$$t = \frac{r\sqrt{n-2}}{\sqrt{1-r^2}} \tag{14}$$

With n is the amount of data and r denotes the correlation coefficient and the t-distribution having $n - 2$ degrees of freedom.

Table 1. The correlation between some inputs against the number of closed down restaurants and hotels

| Correlation variables | | Correlation value | t-test | p-value | Linear relationship |
|-----------------------|-----------------------------------|-------------------|---------|---------|---------------------|
| Positive (Jakarta) | The closed hotels and restaurants | 0.7525 | 8.7764 | 0.0000 | Yes |
| Dead (Jakarta) | The closed hotels and restaurants | 0.7631 | 9.0685 | 0.0000 | Yes |
| Positive (Indonesia) | The closed hotels and restaurants | 0.7127 | 7.8050 | 0.0000 | Yes |
| Dead (Indonesia) | The closed hotels and restaurants | 0.7303 | 8.2114 | 0.0000 | Yes |
| Positive (world) | The closed hotels and restaurants | 0.8084 | 10.4165 | 0.0000 | Yes |
| Dead (world) | The closed hotels and restaurants | 0.7633 | 9.0765 | 0.0000 | Yes |

From Table 1, all the amount of positive casualties in Jakarta (x_1), the amount of dead casualties in Jakarta (x_2), the amount of positive casualties in Indonesia (x_3), the amount of dead casualties in Indonesia (x_4), the amount of positive casualties in the world (x_5), the amount of dead casualties in the world (x_6) have linearity relationship against the amount of closed down hotels and restaurants in Jakarta as output (y).

3.2. Estimation results

Before applying the estimation method, we require to divide the data into two parts: training data and testing data. The proportion is 80% training data and 20% testing data [24]. Figure 19 displays the division between testing data (red plus marks) and training data. We make this pattern for training and testing data because the data is nonstationary. Data used in training and testing data must have resembling characteristics and properties [25].

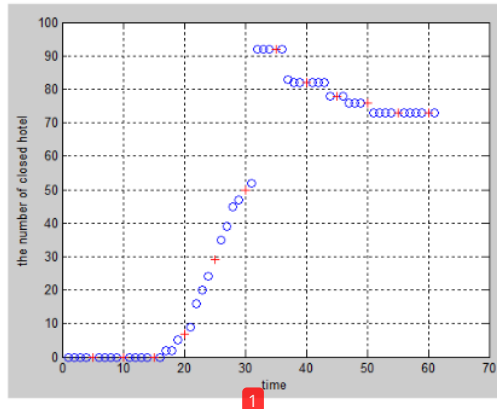

Figure 6. Data divided into two parts: training data (blue) and testing data (red)

The parameters in the simulation of ANFIS are :

- Maximum of epoch : 30
- The amount of membership functions : 2 in each input
- The amount of rules : 64
- The amount of linear parameters (consequents) : 448
- The amount of nonlinear parameters (premises) : 36

The simulation results of ANFIS are shown in the four figures below. Two membership functions are used: the blue curve denotes 'small' and the green curve denotes 'large'. Figure 7 displays the optimized membership functions of inputs such as the amount of positive casualties in Jakarta, the amount of dead casualties in Jakarta, the amount of positive casualties in Indonesia, the amount of dead casualties in Indonesia, the amount of positive casualties in the world, and the amount of dead casualties in the world. Each membership function leverages a generalized bell (gbell) containing three nonlinear parameters. Figure 8 displays the convergence process of RMSE. In the early epoch, and the RMSE was pretty big. During the optimization process, the RMSE is decreased to 0.5324. Figure 9 displays estimation results (the number of closed down restaurants and hotels) on training data. It seems that there are the comparison and error between the target and the output. From the training process until the 30 epoch, it is obtained optimal ANFIS parameters. Then, optimal ANFIS parameters are used in testing data. Figure 10 displays estimation results (the number of closed down restaurants and hotels) on testing data.

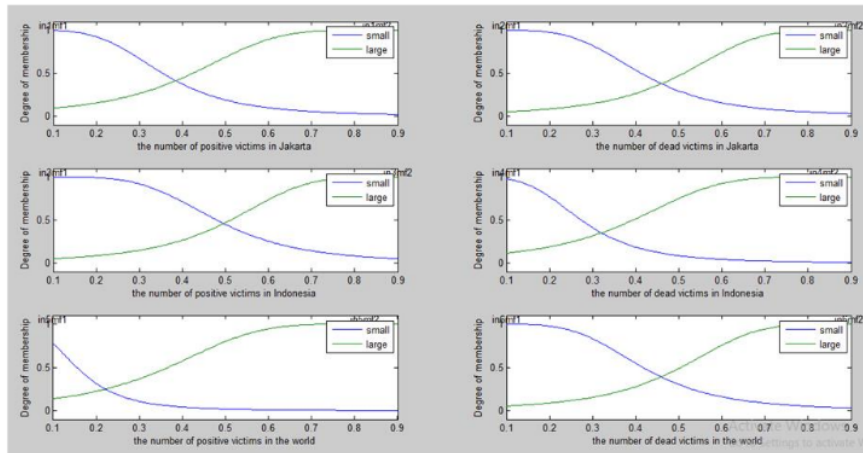

Figure 7. Optimal membership function of ANFIS

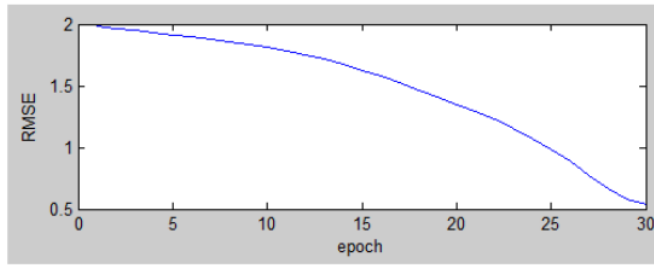

Figure 8. Convergence process of ANFIS

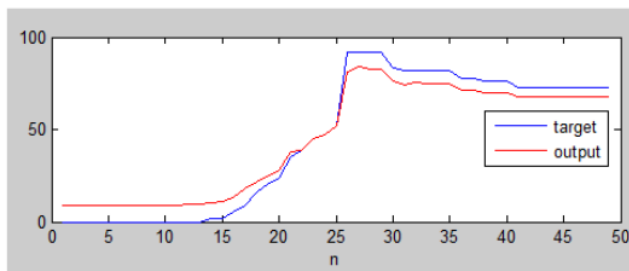

Figure 9. Estimation result on training data of the amount of closed down hotels and restaurants in Jakarta

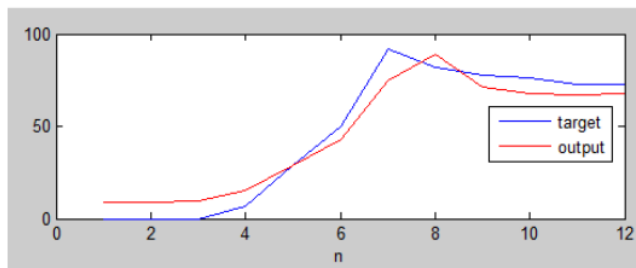

Figure 10. Estimation result on testing data of the amount of closed down hotels and restaurants in Jakarta

From the simulation in Figure 9 and Figure 10, we achieve the estimation with the root of mean square error (RMSE) in equation (13) are :

Data for training : 0.5324
 Data for testing : 5.3198

They seem that error on the testing data is more significant than on the training data.

We replay the simulations five times using other membership functions such as gaussmf resembling normal or gaussian distribution shape, trapmf using trapezoidal shape function, trimf using triangular shape function, pimf, and 42mf. Finally, the results are displayed in Table 2, i.e. root of mean square error (RMSE) on Adaptive Neuro-Fuzzy Inference System with different membership function with maximum epoch is 30.

Table 2. The root of mean square error (RMSE) on ANFIS with other membership functions

| Membership function | Max epoch | RMSE on training data | RMSE on testing data |
|---------------------|-----------|-----------------------|----------------------|
|---------------------|-----------|-----------------------|----------------------|

Paper's should be the fewest possible that accurately describe ... (First Author)

| | | | |
|---------|----|--------|--------|
| Gaussmf | 30 | 0.5375 | 4.8326 |
| Trapmf | 30 | 2.1666 | 3.0560 |
| Trimf | 30 | 1.8291 | 3.9111 |
| Pimf | 30 | 2.1729 | 8.4132 |
| Dsigmf | 30 | 0.4422 | 6.4076 |

They seem that errors on the testing data are more significant than on the training data in all five membership functions.

4. CONCLUSION

In estimating the number of closed down restaurants and hotels using ANFIS, it is required supporting variables such as the amount of positive casualties in Jakarta, the amount of dead casualties in Jakarta, the amount of positive casualties in Indonesia, the amount of dead casualties in Indonesia, the amount of positive casualties in the world, and the amount of dead casualties in the world.

ANFIS can estimate the number of closed down restaurants and hotels approaching the target. Simulations are conducted by dividing the dataset into two parts: training data (80%) and testing data (20%). From ANFIS computations, ANFIS can estimate the amount of closed down restaurants and hotels in data of training with optimal RMSE equals 0.5324 and data of testing with optimal RMSE equals 5.3198.

The improvements of this research are making estimation and classification the results by data mining and machine learning techniques.

23

ACKNOWLEDGEMENTS

This work was fully supported by the LPPM - University of Nahdlatul Ulama Surabaya (UNUSA)

5

REFERENCES

- [1] T. Haryanto, "Editorial : COVID-19 Pandemic and International Tourism Demand," *JDE (Journal of Developing Economies)*, vol. 5, no. 1, 2020, doi:10.20473/jde.v5i1.19767
- [2] KI. Khan, A. Niazi, A. Nasir, M. Hussain, M.I. Khan, "The Effect of COVID-19 on the Hospitality Industry : The Implication for Open Innovation," *Journal of Open Innovation : Technology, Market, and Complexity*, vol. 7, no. 30, 2021, doi:10.3390/joitmc7010030
- [3] OA Torrell, J.P.A. Alarcon and J.V. Perez, "COVID-19 : Hotel Industry Response to the Pandemic Evolution and to the Public Sector Economic Measures," *Tourism Recreation Research*, vol. 46, no. 2, 2021, doi: 10.1080/02508281.2020.1826225
- [4] NPLA Puspita, I.P. Astawa and I.G. Mudana, "Hotel Strategy in Facing the Covid-19 Pandemic (The Westin Resort Nusa Dua Experience)," *International Journal of Global Tourism*, vol. 2, no. 1, 2021
- [5] J. Shing and R. Jang, "ANFIS: Adaptive Network Based Fuzzy Inference System," *IEEE Trans. On System, Man, and Cybernetics*, vol. 23, no. 1, 1993
- [6] M.Y. Anshori, D. Rahmalia and T. Herlambang, "Comparison Backpropagation (BP) and Learning Vector Quantification (LVQ) on Classifying Price Range of Smartphone in Market," *Journal of Physics : Conference Series 1836*, 2021, doi: 10.1088/1742-6596/1836/1/012040
- [7] D. Rahmalia, M.S. Pradana and T. Herlambang, "Klasifikasi Multi Output pada Harga Smartphone Menggunakan Learning Vector Quantization (LVQ) dan Backpropagation," *SYSTEMIC Information System and Informatics Journal*, vol. 6, no. 2, 2020, doi: 10.29080/systemic.v6i2.967
- [8] R. Rajkumar, A.J. Albert, and D. Chandrakala, "Weather Forecasting using Fuzzy Neural Network (FNN) and Hierarchy Particle Swarm Optimization Algorithm (HPSO)", *Indian Journal of Science and Technology*, vol. 18, no.2, 2015, doi: 10.17485/ijst/2015/v8i12/52708
- [9] D. Karaboga and E. Kaya, "Training ANFIS by Using the Artificial Bee Colony Algorithm," *Turkish Journal of Electrical Engineering and Computer Sciences* vol. 25, 2017, doi: 10.3906/elk-1601-240
- [10] M.Y. Anshori, D. Rahmalia, T. Herlambang, and DF Karya, "Optimizing Adaptive Neuro Fuzzy Inference System (ANFIS) Parameters Using Cuckoo Search (Case Study of World Crude Oil Price Estimation)," *Journal of Physics : Conference Series 1836*, 2021, doi: 10.1088/1742-6596/1836/1/012041
- [11] D. Rahmalia, "Estimation of Exponential Smoothing Parameter on Pesticide Characteristic Forecast Using Ant Colony Optimization (ACO)," *Eksakta : Jurnal Ilmu-ilmu MIPA*, vol. 18, no. 1, pp. 56-63, 2018, doi: 10.20885/eksakta.vol18.iss1.art6
- [12] D.C. Montgomery, C.L. Jennings, M. Kulahci, *Introduction to Time Series Analysis and Forecasting*, New Jersey: Wiley, 2015.
- [13] M.Y. Anshori, T. Herlambang, D.F. Karya, D. Rahmalia, "H-Infinity for World Crude Oil Price Estimation," *Journal of Physics : Conference Series 1563*, 2020, doi:10.1088/1742-6596/1563/1/012016
- [14] T. Herlambang, Z. Mufarrikhoh, D.F. Karya and D. Rahmalia, "Estimation of Water Level and Steam Temperature Using Ensemble Kalman Filter Square Root (EnKF-SR)," *Journal of Physics : Conference Series 1008*, 2018, doi: 10.1088/1742-6596/1008/1/012026
- [15] DF Karya, P. Katias, T. Herlambang, and D. Rahmalia, "Development of Unscented Kalman Filter Algorithm for Stock Price Estimation," *Journal of Physics : Conference Series 1211*, 2019, doi: 10.1088/1742-6596/1211/1/012031
- [16] A. Muhith, T. Herlambang, Irhamah and D. Rahmalia, "Estimation of Thrombocyte Concentrate (TC) and Whole Blood (WB) Using Unscented Kalman Filter," *International Journal of Advanced Science and Technology*, vol. 9, no. 8, 2020
- [17] A. Muhith, T. Herlambang, M.Y. Anshori, R. Rizqina, and D. Rahmalia, "Estimation of Whole Blood (WB) and Anti-Hemophilate Factor Using Extended Kalman Filter in PMI Surabaya," *Journal of Physics : Conference Series 1538*, 2020, doi: 10.1088/1742-6596/1538/1/012034
- [18] A. Muhith, T. Herlambang, A. Haris and D. Rahmalia, "Estimation of Whole Blood (WB) Using Unscented Kalman Filter in Surabaya," *IOP Conference Series :Materials Science and Engineering 874*, 2020, doi: 10.1088/1757-899X/874/1/012028

- [19] L.A. Matarneh, A. Sheta, S. Bani-Ahmad, J. Alshaer, and I. Al-oqily, "Development of Temperature-based Weather Forecasting Models Using Neural Network and Fuzzy Logic", *International Journal of Multimedia and Obiquitous Engineering*, vol. 9 no. 12, 2014, doi: 10.14257/ijmue.2014.9.12.31
- [20] D. Rahmalia et al, "Comparison between Neural Network (NN) and Adaptive Neuro Fuzzy Inference System (ANFIS) on Sunlight Intensity based on Air Temperature and Humidity," *Journal of Physics : Conference Series 1538*, 2020, doi: 10.1088/1742-6596/1538/1/12044
- [21] J. Lu., S. Xue, X. Zhang, S. Zhang, and W. Lu, "Neural Fuzzy Inference System-Based Weather Prediction Model and Its Precipitation Prediction Experiment," *Atmosphere*, vol. 5, 2014 doi: 10.3390/atmos5040788
- [22] W. Suparta and K.M. Alhasa, "Modelling of Tropospheric Delays Using ANFIS," *SpringerBriefs in Meteorology*, 2016, doi: 10.1007/978-3-319-28437-8_2
- [23] R.E. Walpole, R.H. Myers, S.L. Myers, K. Ye, *Probability and Statistics for Engineers and Scientists*, USA: Prentice Hall, 2012.
- [24] J. Han, M. Kamber, J. Pei, *Data Mining Concepts and Techniques.*, USA: Elsevier, 2012.
- [25] D. Rahmalia and M.S. Pradana, "Backpropagation Neural Network pada Data yang tak Stasioner (Studi kasus : Jumlah Penderita Penyakit Ebola)," *Jurnal Riset dan Aplikasi Matematika (JRAM)*, vol. 3, no. 1, pp. 32-42, 2019, doi: 10.26740/jram.v3n1.p32-42

Estimation of Closed Hotels and Restaurants in Jakarta as Impact of Corona Virus Disease (Covid-19) Spread Using Adaptive Neuro Fuzzy Inference System

ORIGINALITY REPORT

20%
SIMILARITY INDEX

11%
INTERNET SOURCES

15%
PUBLICATIONS

3%
STUDENT PAPERS

PRIMARY SOURCES

| | | |
|----------|--|-----------|
| 1 | D Rahmalia, T Herlambang, A S Kamil, R A Rasyid, F Yudianto, L Muzdalifah, E F Kurniawati. "Comparison between Neural Network (NN) and Adaptive Neuro Fuzzy Inference System (ANFIS) on sunlight intensity prediction based on air temperature and humidity", Journal of Physics: Conference Series, 2020 Publication | 6% |
| 2 | journal.umg.ac.id Internet Source | 3% |
| 3 | Submitted to Sultan Agung Islamic University Student Paper | 2% |
| 4 | Submitted to Turiba University Student Paper | 1% |
| 5 | repository.unusa.ac.id Internet Source | 1% |

| | | |
|-----------------|--|------|
| 6 | Hendro Nurhadi, Erna Apriliani, Teguh Herlambang, Dieky Adzkiya. "Sliding mode control design for autonomous surface vehicle motion under the influence of environmental factor", International Journal of Electrical and Computer Engineering (IJECE), 2020 | 1 % |
| Publication | | |
| 7 | T. Herlambang, D. Adzkiya, H. Nurhadi. "Trajectory Estimation of Autonomous Surface Vehicle Using Extended Kalman Filter", Journal of Physics: Conference Series, 2020 | 1 % |
| Publication | | |
| 8 | www.e-journal.unair.ac.id | 1 % |
| Internet Source | | |
| 9 | M Y Anshori, D Rahmalia, T Herlambang. "Comparison Backpropagation (BP) and Learning Vector Quantification (LVQ) on classifying price range of smartphone in market", Journal of Physics: Conference Series, 2021 | <1 % |
| Publication | | |
| 10 | eprints.hud.ac.uk | <1 % |
| Internet Source | | |
| 11 | 369485e5-78d9-4695-8ee7-77e624124993.filesusr.com | <1 % |
| Internet Source | | |

12 K.V. Shihabudheen, G.N. Pillai. "Recent advances in neuro-fuzzy system: A survey", Knowledge-Based Systems, 2018 <1 %
Publication

13 T. N. Singh, V. K. Singh, S. Sinha. "Prediction of Cadmium Removal Using an Artificial Neural Network and a Neuro-Fuzzy Technique", Mine Water and the Environment, 2006 <1 %
Publication

14 Submitted to University of Nottingham <1 %
Student Paper

15 espace.library.uq.edu.au <1 %
Internet Source

16 Bülent Haznedar, Adem Kalinli. "Training ANFIS structure using simulated annealing algorithm for dynamic systems identification", Neurocomputing, 2018 <1 %
Publication

17 Choayb Djeddi, Ahmed Hafaifa, Abdelhamid Iratni, Nadji Hadroug, XiaoQi Chen. "Robust diagnosis with high protection to gas turbine failures identification based on a fuzzy neuro inference monitoring approach", Journal of Manufacturing Systems, 2021 <1 %
Publication

18 umpir.ump.edu.my <1 %
Internet Source

19

Omar Al-Jarrah, Faruq A. Al-Omari.

"IMPROVING GESTURE RECOGNITION IN THE ARABIC SIGN LANGUAGE USING TEXTURE ANALYSIS", Applied Artificial Intelligence, 2007

Publication

<1 %

20

researchbank.swinburne.edu.au

Internet Source

<1 %

21

Khaled M. El-Sawy, Abdel Latif Elshafei.

"Neural network for the estimation of the inelastic buckling pressure of loosely fitted liners used for rigid pipe rehabilitation", Thin-Walled Structures, 2003

Publication

<1 %

22

journal2.unusa.ac.id

Internet Source

<1 %

23

managementjournal.usamv.ro

Internet Source

<1 %

24

Abdulkadir Cüneyt Aydın, Ahmet Tortum, Murat Yavuz. "Prediction of concrete elastic modulus using adaptive neuro-fuzzy inference system", Civil Engineering and Environmental Systems, 2006

Publication

<1 %

25

M. AbdulHadi, A.M. Al-Ibrahim, G.S. Virk.

"Neuro-Fuzzy-Based Solar Cell Model", IEEE Transactions on Energy Conversion, 2004

Publication

<1 %

26

T Herlambang, Z Mufarrikoh, D F Karya, D Rahmalia. "Estimation of water level and steam temperature using ensemble Kalman filter square root (EnKF-SR)", Journal of Physics: Conference Series, 2018

Publication

<1 %

27

M Y Anshori, D Rahmalia, T Herlambang, D F Karya. "Optimizing Adaptive Neuro Fuzzy Inference System (ANFIS) parameters using Cuckoo Search (Case study of world crude oil price estimation)", Journal of Physics: Conference Series, 2021

Publication

<1 %

Exclude quotes On

Exclude matches Off

Exclude bibliography On